

ROTADAIRON®

DS 180

DETHATCHER FOR TRACTOR

SOIL PREPARATION

SEEDING

OVERSEEDING

DETHATCHING
SPIKING

MULCHING



MADE IN FRANCE

DETHATCHER FOR TRACTOR

Functions of the dethatcher DS 180

The DS Dethatchers Spikers are the evolution of our proven «ED» models well known for their superior dethatching qualities with their unique blade fixing system, accepting 3 variants of knives to precisely meet your needs.

This Rotadairon® DS 180 dethatching machine allows to perform dethatching or scarifying operations at the desired depth (from 0 to 60 mm). In addition to these operations, the machine allows to carry out an aeration of the ground (spiking effect, without power take-off) or a rolling. The machine is equipped with a quick-change blade system (Rotadairon® patent). The blades are positioned magnetically on their support. All the supports are locked by a single nut at the end of the rotor axis.

The DS offer is flexible, with a basic machine and two additional options:

- Basic version including a single front roller
- A first option: additional rear roller for more precision
- A second «SWING» option to allow optimum flexibility on hilly terrain.

Quality of service

A large stock of spare parts is permanently maintained at our factory. Our partners have online tools and quick access to manufacturer information. Maintain the quality and performance of your Rotadairon® by using only original parts.

- 1 Basic version with front roller
- 2 Option n°1 : Rear roller
- 3 Option n°2 : « SWING » (Option 1 required)
- 4 3 knife configurations :
 - a Sharpened (standard): Stainless steel knife sharpened for classic de-thatching
 - b Not sharpened: Made of stainless steel knives not sharpened for more aggressive de-thatching
 - c Carbide plate: Carbon steel with carbide plate for very aggressive de-thatching
- 5 Magnetic knife positioning (quick change)
- 6 Unique nut at the end of the rotor shaft

Machine	DS 180
Working width	1800 mm (70" 3/4)
Total width	1945 mm (76" 2/3)
Weight	330 Kg (728 lb) With option n°1 : 365 Kg (805 lb) With option n°1 & 2 : 389 Kg (858 lb)
Tractor : Required power	30 - 45 CV
Working depth	0 to 60 mm (0" to 2" 1/4)
Distance between knives	24 mm (15/16")
Rotor outer diameter	360 mm (14" 1/4)
Depth adjustment	Basic machine: Adjustment at the 3rd Points Machine with options: Height adjustable rollers
Number of flanges	74
Number of knives	222
3 point hitch	Categories 1 & 2
PTO speed	540 tr/min
Tractor forward speed	3 to 8 Km/h (1.8 to 4.9 mph)
Transmission	Angle gearbox + Oil bath chain
Transport dimension w x L x H	1945 mm x 895 mm x 840 mm (76" 2/3 x 35" 1/4 x 33")
Options	Option n°1 : Rear roller Option n°2 : « SWING »

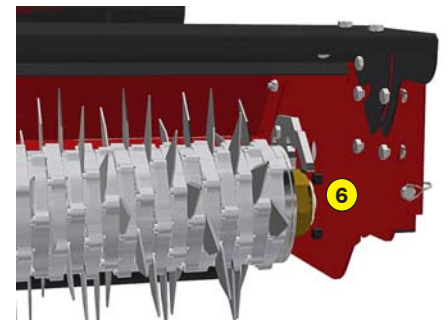
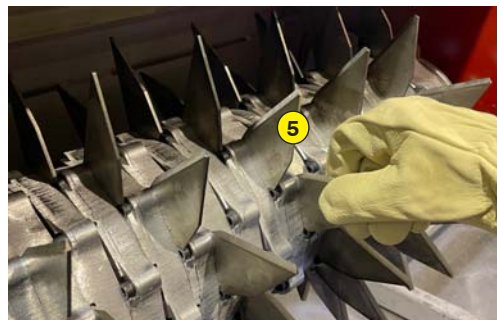
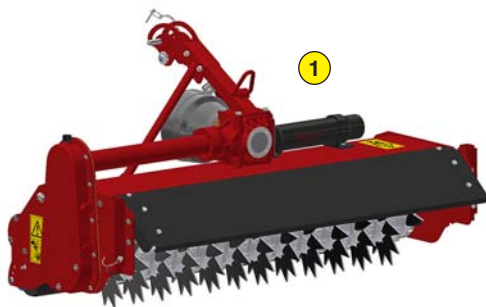

ROTADAIRON
Départementale 92 - Les Hunaudières
72230 Mulsanne - France
Mail : contacts@rotadairon.fr
Phone number : (33) 2 43 422 422



www.rotadairon.fr