



DESIGNER AND MANUFACTURER OF EQUIPMENTS
FOR THE BUILDING AND MAINTENANCE OF GREEN SPACES



PRODUCT CATALOGUE

MADE IN FRANCE



WHY CHOOSE ROTADAIRON ?

Like us, you appreciate the job well done. Our tools benefit from more than 65 years' experience and the constant desire to build a « perfect machine ». Whether it is our soil preparers, our seeding machines, our overseeders, dethatcher-spiker or our mulchers, they have all been designed with the same objective: that you can have a quality tool for a long time. Carry out your projects day after day with a professional look. Be proud of your achievements !

DESIGNER AND MANUFACTURER SINCE 1958

We have always made the choice to master in-house the design and manufacture of our products. All our employees are involved in the process of designing and finalizing new products. It is indeed the integration of the proposals of our welders, machinists, assemblers to the designs of our integrated design office that will allow us to provide you with the innovative and unique product you are looking for.



This product is of course at the beginning, the result of the feedback of the field experience acquired around the world with you, our customers. We guarantee quality customer service, high availability of spare parts thanks to a large stock and our internal manufacturing.

We know that it is this virtuous cycle that will allow us to keep customer goodwill.



CUSTOMER SATISFACTION

Your satisfaction is our priority, from equipment selection to day-to-day and long-term use



ROBUST MACHINES

We have always made the choice to manufacture durable goods : « quality since 1958 »



A FRENCH MANUFACTURE

We design AND manufacture in France and work with regional partners



AN INCOMPARABLE RESULT

You are proud of what you have achieved with your equipment !

OUR 360° SOLUTIONS FOR GREEN SPACE

Special applications

Page : 75

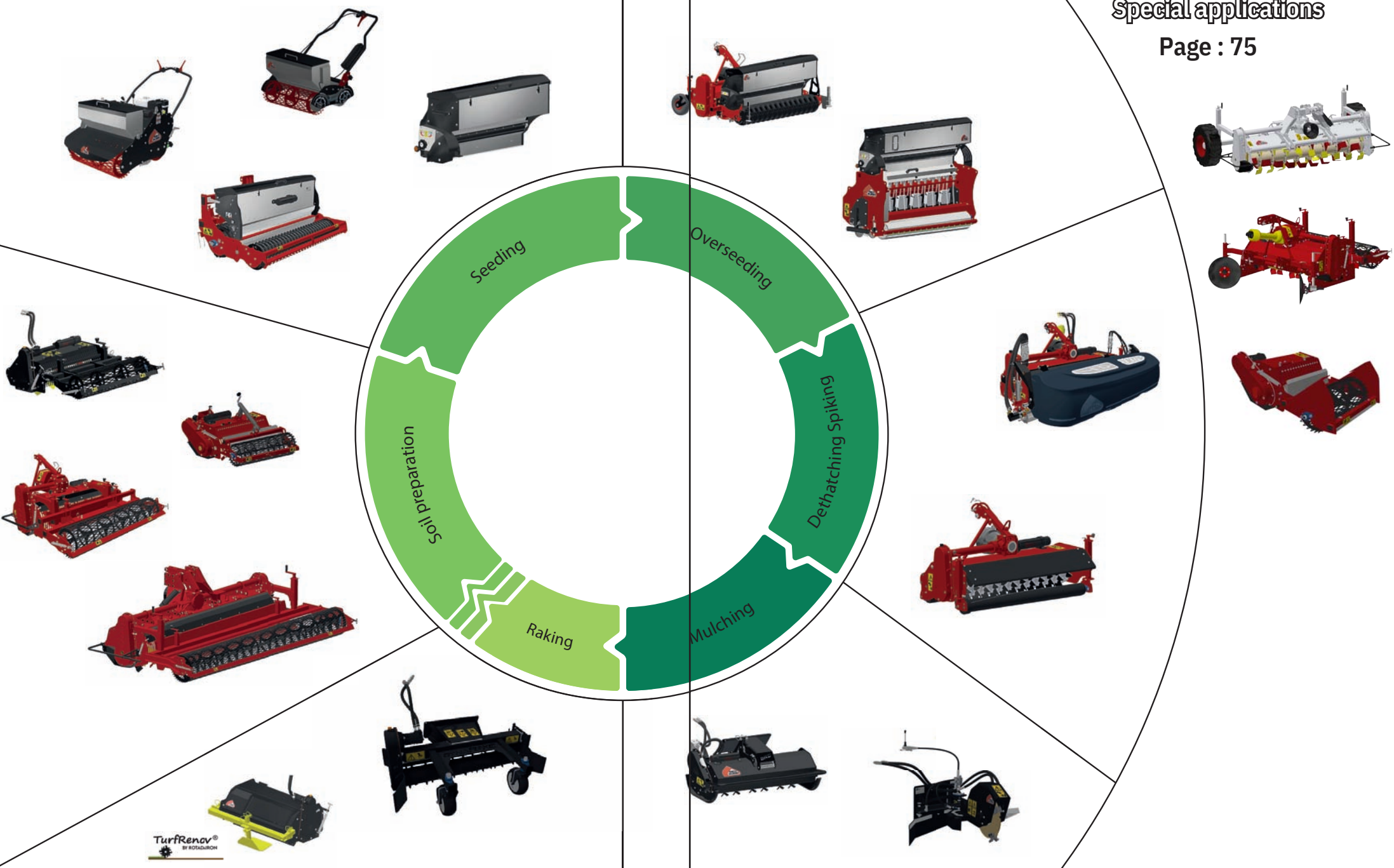

RAKING



P. 8



P. 10

DYNARAKE



The ROTADAIRON[®] **Zéro Phyto** solution for old turf renovation. *TurfRenov[®]* is a stripping kit that fits on your soil preparer ROTADAIRON[®]. The **TurfRenov[®]** kit can be completed with an optional control kit.

TurfRenov[®] BY ROTADAIRON

MONEY SAVING

Only 1 carrier is necessary



PRODUCTIVITY

A single time intervention (*)



QUALITY

Respect the leveling of the land



(*) raking, removal of waste and decompacting if necessary, soil preparation prior to seeding the surface.



TurfRenov[®] Kit (See STH 36 P.16)



TurfRenov[®] kit control



Picks

Universal quick-hitch plate

After TurfRenov, ROTADAIRON introduces a new tool to optimize old grass renovation in «ZERO PHYTO».

Use the DynaRAKE to strip the old turf and its collar to a reduced thickness.

Use the DynaRAKE to evacuate debris and shape your lawn before using the ROTA-DAIRON soil preparer.

Extend your applications to resurfacing gravel roads !

Technical details :

Machine	DynaRAKE 50	DynaRAKE 50 B
Hitch plate	Toro / Ditch Witch / Vermeer	Bobcat MT
Working width	1250 mm (49" 2/5)	
Total width	1495 mm (58" 4/5)	
Weight	230 Kg (507 lb)	245 Kg (540 lb)
Carrier : Hydraulic flow	40 à 65 l/min (10.5 to 15.8 US gpm)	
Carrier : Pressure	210 Bars (2900 psi)	
Carrier : Maximum track width	1.25 meters (49" 2/5)	
Number of picks	74	
Forward speed	0.8 à 1.5 Km / h (0.5 to 0.9 mph)	
Transmission	Hydraulic motor + oil bath chain	
Security	Made by the carrier	
Transport dimension w x L x H	1495 mm x 1120 mm x 670 mm (58" 4/5 x 44" 1/10 x 26" 1/2)	

SOIL PREPARATION



P. 14



P. 16



P. 18

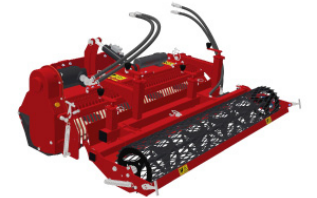
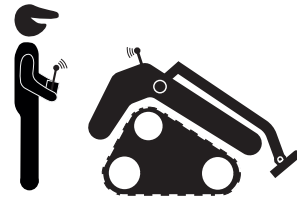

P. 22



P. 24



P. 28



RAPID hitch



Option : Working depth setting by hydraulic jack

This soil preparer and stone burier is thought for cultivators. This machine has been designed to perform tilling to 140 mm, burying pebbles/litter/grass, levelling with adjustable levelling blade, rolling with metal mesh roller. The use is made in direct or on a ground previously decompacted in depth and cleared of large stones.

Technical details :

Machine	STM 75	
Coupling head	RAPID/REFORM, NIBBI, AGRIA*, AEBI (Other brands, contact us) *AGRIA adaptor not supplied	
Working width	750 mm (29" 1/2)	
Total width	960 mm (37" 3/4)	
Weight	STM 75 RAPID/REFORM : 167 Kg (368 lb)	STM 75 NIBBI : 160 Kg (352.7 lb)
	STM 75 AGRIA : 159 Kg (350.5 lb)	STM 75 AEBI : 155 Kg (341.7 lb)
Tiller : max track width	0.98 meter (38" 1/2)	
Working depth (max)	140 mm (5" 1/2)	
Rotor outer diameter	400 mm (15" 3/4)	
Depth adjustment	Screw jack system	
Number of blades	16	
Grid finger spacing	22 mm (7/8")	
PTO speed	920 tr/min (clockwise) for RAPID/REFORME, NIBBI, AGRIA, AEBI	
Forward speed	0.8 to 1.5 Km / h (0.5 to 0.9 mph)	
Transmission	Angle gearbox + oil bath chain	
Security	Oil bath torque limiter at the end of the rotor	
Transport dimension w x L x H	960 mm x 1215 mm x 590 mm (37" 3/4 x 47" 3/4 x 23" 1/4)	
Option	- Working depth setting by hydraulic jack	



Option : Fast coupling / uncoupling device



Option : SG Gravity grass seeder (See SG P.50)

These soil and stone buriers are designed for Skid-Steer (mini-loader). There are three versions of the machine hitch:

- Toro / Ditch Witch / Vermeer type hitch plate : STH 36 / STH 42
- Bobcat type hitch plate : STH 36 B
- Adaptable to your carrier by your own : supplied without hitch plate, without hoses, without couplers : STH 36 / 42 ADAPT

It allows the building or renovation of green spaces by preparing the seed bed before seeding. The machine is multi-purpose, it allows tilling, burying (stones, rubbish, herbs, etc.), levelling, mixing and rolling the surface. The use is done live or on a ground previously decompacted in depth and cleared of large stones.

Technical details :

Machines	STH 36			STH 42		
Model	STH 36	STH 36 B	STH 36 ADAPT	STH 42	STH 42	STH 42 B
Hitch plate	Toro / Ditch Witch / Vermeer	Bobcat MT	Without hitch plate, without hoses, without coupler	Toro / Ditch Witch / Vermeer	Without hitch plate, without hoses, without coupler	Bobcat MT
	For specific request, please contact us					
Working width	963 mm (38")			1100 mm (43" 1/4)		
Total width	1330 mm (52" 1/4)			1440 mm (56" 3/4)		
Weight	265 Kg (584.2 lb)	280 Kg (650.3 lb)	255 Kg (562.2 lb)	285 Kg (628.3 lb)	275 Kg (606.2 lb)	305 Kg (672.4 lb)
Carrier : Hydraulic flow	30 to 45 l/min (7,9 to 11,8 US gpm)			40 to 55 l/min (10,5 to 14,5 US gpm)		
Carrier : Pressure	200 to 250 Bars (2900 to 3625 psi)					
Carrier : Maximum track width	1.15 meters (45" 1/4)	1 meter (39" 1/3)	-	1.30 meters (51" 1/4)	-	1.15 meters (45" 1/4)
Working depth (max)	140 mm (5" 1/2)					
Rotor outer diameter	400 mm (15" 3/4)					
Depth adjustment	Rear roller height adjustable 4 positions					
Number of blades	20			24		
Grid finger spacing	22 mm (7/8")					
Forward speed of the carrier	0.8 to 1,5 Km/h (0.5 to 0.9 mph)					
Transmission	Hydraulic motor + chain in oil bath					
Security	Made by the carrier					
Transport dimension w x L x H	1325mm x 1545mm x 620mm (52"1/4 x 60"3/4 x 24"1/2)			1440mm x 1545mm x 620mm (56"3/4 x 60"3/4 x 24"1/2)		
Options	<ul style="list-style-type: none"> - Fast coupling / uncoupling device - Rear mesh roller side adjustment device by cylinder (Requires auxiliary hydraulic line) - TurfRenov® Kit ; Kit control TurfRenov® (see P.8) - Gravity Grass Seeder : SG 90 for STH 36 ; SG 100 for STH 42 					

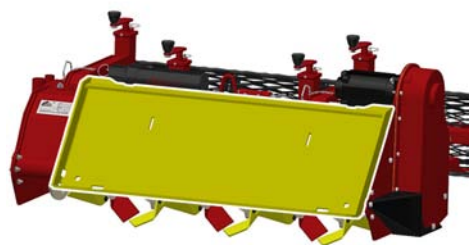

Conventional quick hook system



Option : Cast iron roller disc chassis

These soil preparers and stone buriers are intended for hydraulic loaders. There are two versions of the machine hitch:

- Bobcat type hitch plate : RDH 52 / 60
- Adaptable to your carrier by your own : supplied without hitch plate, without hoses, without couplers : RDH 52 / 60 ADAPT

It allows the building or renovation of green spaces by preparing the seed bed before seeding. The machine is multi-purpose, it allows tilling, burying (stones, rubbish, herbs, etc.), levelling, mixing and rolling the surface. The use is made in direct or on a ground previously decompacted in depth and cleared of large stones.

Technical details :

Machines	RDH 52		RDH 60	
	RDH 52	RDH 52 ADAPT	RDH 60	RDH 60 ADAPT
Model	RDH 52	RDH 52 ADAPT	RDH 60	RDH 60 ADAPT
Hitch plate	Bobcat	Without hitch plate, without hoses, without coupler	Bobcat	Without hitch plate, without hoses, without coupler
	For specific request, please contact us			
Working width	1340 mm (52'' 3/4)		1500 mm (59'')	
Total width	1730 mm (68'')		1830 mm (72'')	
Weight	450 Kg (992 lb)	415 Kg (915 lb)	500 Kg (1102,3 lb)	465 Kg (1025,1 lb)
Carrier : Hydraulic flow	70 to 120 l/min (18,5 to 31,7 US gpm)			
Carrier : Pressure	210 to 300 Bars (3045 to 4350 psi)			
Carrier : Maximum track width	1,48 meters (58'' 1/4)	-	1,8 meters (70'' 4/5)	-
Working depth (max)	140 mm (5'' 1/2)			
Rotor outer diameter	Ø 400 mm (15'' 3/4)			
Depth adjustment	Support on rear roller adjustable by screw jacks			
Number of blades	28		32	
Grid finger spacing	20 mm (4/5'')			
Forward speed of the carrier	0.8 to 1.5 Km/h (0.5 to 0.9 mph)			
Transmission	Hydraulic motor + chain in oil bath			
Security	Made by the carrier			
Transport dimension w x L x H	1700 mm x 1570 mm x 700 mm (67'' x 61'' 3/4 x 27'' 1/2)		1905 mm x 1570 mm x 700 mm (75'' x 61'' 3/4 x 27'' 1/2)	

Options

- Cast-iron notched discs roller frame
- Rear mesh roller side adjustment device by cylinder (Requires auxiliary hydraulic line)
- Gravity Grass Seeder : SG 130 for RDH 52 and SG 145 for RDH 60



This soil preparer and stone burier is intended for hydraulic loaders with Bobcat hitch plate.

It allows the building or renovation of green spaces by preparing the seed bed before seeding. The machine is multi-purpose, it allows tilling, burying (stones, rubbish, herbs, etc.), levelling, mixing and rolling the surface. The use is made in direct or on a ground previously decompacted in depth and cleared of large stones.

Technical details :

Machines	RDH 70
Hitch plate	Bobcat
Working width	1774 mm (69" 3/4)
Total width	2130 mm (84")
Weight	780 Kg (1719.6 lb)
Carrier : Hydraulic flow	70 to 120 l/min (18,5 to 31,7 US gpm)
Carrier : Pressure	210 to 300 Bars (3045 to 4350 psi)
Carrier : Maximum track width	2,15 meters (84" 2/3)
Working depth (max)	160 mm (6" 1/4)
Rotor outer diameter	Ø 510 mm (20")
Depth adjustment	Support on rear roller adjustable by screw jacks
Number of blades	54
Grid finger spacing	20 mm (4/5")
Forward speed of the carrier	0.8 to 1.5 Km/h (0.5 to 0.9 mph)
Transmission	Hydraulic motor + chain in oil bath
Security	Made by the carrier
Transport dimension w x L x H	2140 mm x 1900 mm x 850 mm (84" 1/4 x 74" 3/4 x 33" 1/2)

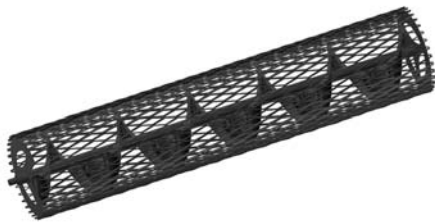

Option : Spiral roller



Option : Roller side adjustment device by cylinder

Options

- Spiral roller
- Roller side adjustment device by cylinder (Requires auxiliary hydraulic line)



MDB type hitch plate



Option : Hydraulic movement of the mesh metal roller frame

These soil preparers and stone burier are intended for remote controlled tool carrier. There are two versions of the machine hitch :

- MDB type hitch plate : RCH 60 MDB
- Adaptable to your carrier by your own : supplied without hitch plate, without hoses, without couplers : RCH 60 ADAPT

It allows the building or renovation of green spaces by preparing the seed bed before seeding. The machine is multi-purpose, it allows tilling, burying (stones, rubbish, herbs, etc.), levelling, mixing and rolling the surface. The use is done live or on a ground previously decompacted in depth and cleared of large stones.

Technical details :

Machine	RCH 60	
	RCH 60 MDB	RCH 60 ADAPT
Model	RCH 60 MDB	RCH 60 ADAPT
Hitch plate	MDB type hitch plate	Without hitch plate, without hoses, without coupler
	For specific request, please contact us	
Working width	1500 mm (59")	
Total width	1830 mm (72")	
Weight	460 Kg (1014 lb)	465 Kg (1025,1 lb)
Carrier : Hydraulic flow	70 to 120 l/min (18,5 to 31,7 US gpm)	
Carrier : Pressure	210 to 300 Bars (3045 to 4350 psi)	
Carrier : Maximum track width	1,8 meters (70" 4/5)	-
Working depth (max)	140 mm (5" 1/2)	
Rotor outer diameter	Ø 400 mm (15" 3/4)	
Depth adjustment	Support on rear roller adjustable by screw jacks	
Number of blades	32	
Grid finger spacing	20 mm (4/5")	
Couplers	MDB Faster motor supply coupler not supplied Hydraulic 3-point couplers : 3/8"	-
Forward speed of the carrier	0.8 to 1.5 Km/h (0.5 to 0.9 mph)	
Transmission	Hydraulic motor + chain in oil bath	
Security	Made by the carrier	
Transport dimension w x L x H	1905 mm x 1605 mm x 700 mm (75" x 63" 1/4 x 27" 1/2)	
Option	- Rear mesh roller side adjustment device by cylinder (Requires auxiliary hydraulic line) - Gravity Grass Seeder : SG 145	



These soil preparers and stone buriers are designed for micro-tractors. It allows the building or renovation of green spaces by preparing the seed bed before seeding. The machine is multi-purpose, it allows tilling, burying (stones, rubbish, herbs, etc.), levelling, mixing and rolling the surface. The use is done live or on a ground previously decompacted in depth and cleared of large stones.

Technical details :

Machines	Stony 75	Stony 90	Stony 115
Working width	750 mm (29" 1/2)	963 mm (38")	1100 mm (43" 1/4)
Total width	1210 mm (47" 3/4)	1382 mm (54" 1/2)	1520 mm (59" 3/4)
Weight	265 Kg (584.2 lb)	285 Kg (628.3 lb)	340 Kg (749.5 lb)
Tractor : Required power	15 - 18 CV	18 - 25 CV	20 - 25 CV
Tractor : Max track width	0.92 meter (36" 1/5)	1.05 meters (41" 1/3)	1.33 meters (40" 2/3)
Working depth (max)	140 mm (5" 1/2)		
Rotor outer diameter	400 mm (15" 3/4)		
Depth adjustment	Rear roller height adjustable 4 positions		
Number of blades	16	20	24
Grid finger spacing	22 mm (7/8")		
3 point hitch	Categories 1 & 2		
PTO speed	540 tr/min		
Tractor forward speed	0.8 to 1,5 Km/h (0.5 to 0.9 mph)		
Transmission	Angle gearbox + Oil bath chain		
Security	Oil bath torque limiter at the end of the rotor		
Transport dimension w x L x H	1210mm x 1450mm x 820mm (47" 3/4 x 57" x 32" 1/4)	1382mm x 1560mm x 830mm (54" 1/2 x 61" 1/2 x 32" 3/4)	1520mm x 1625mm x 845mm (59" 3/4 x 64" x 33" 1/4)



Option : Hydraulic movement of the mesh metal roller frame



Option : Stainless Steel Splice Seeder (SMC) or Gravity Grass Seeder (SG)

Options

- Stainless Steel Splice Seeder or Gravity Grass Seeder :
 - SMC 90 ; SG 90 for Stony 90
 - SMC 100 ; SG 100 for Stony 115
- Rear mesh roller side adjustment device by cylinder for the Stony 90 & Stony 115

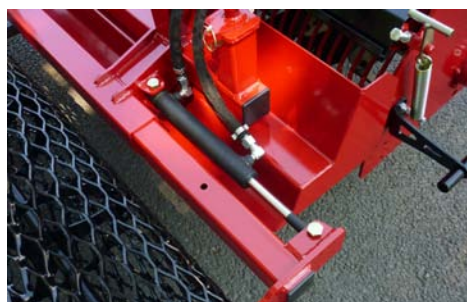

Option : Hydraulic movement of the mesh metal roller frame

Option : Stainless Steel Splice Seeder (SMC) or Gravity Grass Seeder (SG)

These soils preparer and stone buriers are designed for tractors. It allows the building or renovation of green spaces by preparing the seed bed before seeding. The machine is multi-purpose, it allows tilling, burying (stones, rubbish, herbs, etc.), levelling, mixing and rolling the surface. The use is done live or on a ground previously decompacted in depth.

Technical details :

Machines	RD 100	RD 130	RD 145
Working width	1100 mm (43" 1/4)	1338 mm (52" 3/4)	1500 mm (59")
Total width	1610 mm (63" 1/2)	1840 mm (72" 1/2)	2005 mm (79")
Weight with mesh metal roller	405 Kg (892.8 lb)	450 Kg (992 lb)	515 Kg (1135.3 lb)
Tractor : required power	22 - 35 CV	25 - 45 CV	30 - 50 CV
Tractor : max track width	1.34 meters (52" 3/4)	1.62 meters (63" 3/4)	1.54 meters (60" 5/8)
Working depth (max)	140 mm (5" 1/2)		
Rotor outer diameter	400 mm (15" 3/4)		
Depth adjustment	Support on rear roller adjustable by screw jacks		
Number of blades	36	42	48
Grid finger spacing	20 mm (4/5")		
3 point hitch	Categories 1 & 2		
PTO speed	540 tr/min		
Tractor forward speed	0.8 to 1.5 Km/h (0.5 to 0.9 mph)		
Transmission	Angle gearbox + Oil bath chain		
Security	Oil bath torque limiter at the end of the rotor		
Transport dimension w x L x H	1520mm x 1570mm x 995mm (59" 3/4 x 61" 3/4 x 39" 1/4)	1760mm x 1570mm x 995mm (69" 1/4 x 61" 3/4 x 39" 1/4)	1920mm x 1570mm x 1065mm (75" 1/2 x 61" 3/4 x 42")
Weight with cast iron notched disc roller		525 kg (1157.4 lb)	615 Kg (1355.8 lb)

Options

- Rear mesh roller side adjustment device by cylinder
- Cast-iron notched discs roller frame (RD 130 / RD 145)
- Stainless Steel Splice Seeder : SMC 100 / SMC 130 / SMC 145
- Gravity Grass Seeder : SG 100 / SG 130 / SG 145

RDL 150/180/200/250

STONE BURIERS FOR TRACTORS

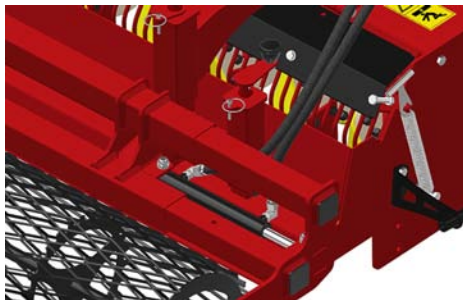

Option : Hydraulic movement of the mesh metal roller frame



Option : Stainless Steel Splice Seeder (SMC) or Gravity Grass Seeder (SG)

These soils preparer and stone buriers are designed for tractors. It allows the building or renovation of green spaces by preparing the seed bed before seeding. The machine is multi-purpose, it allows tilling, burying (stones, rubbish, herbs, etc.), levelling, mixing and rolling the surface. The use is done live or on a ground previously decompacted in depth.

Technical details :

Machines	RDL 150	RDL 180	RDL 200	RDL 250
Working width	1500 mm (59")	1774 mm (69" 3/4)	1984 mm (78")	2492 mm (98")
Total width	1950 mm (76" 3/4)	2240 mm (88" 1/4)	2475 mm (97" 1/2)	2944 mm (116")
Weight with mesh metal roller	798 Kg (1759.2 lb)	915 Kg (2017.2 lb)	965 Kg (2127.4 lb)	1134 Kg (2500 lb)
Tractor : Required power	45 - 60 CV	50 - 70 CV	55 - 80 CV	70 - 90 CV
Tractor : Max track width	1.80 meters (71")	1.84 meters (72" 1/2)	1.91 meters (75" 1/5)	2.35 meters (92" 1/2)
Working depth (max)	160 mm (6" 1/4)			
Rotor outer diameter	510 mm (20")			
Depth adjustment	Support on rear roller adjustable by screw jacks			
Number of blades	48	54	60	72
Grid finger spacing	20 mm (4/5")			
3 point hitch	Categories 1 & 2			
PTO speed	540 tr/min			
Tractor forward speed	0,8 to 1,5 Km/h (0.5 to 0.9 mph)			
Transmission	Angle gearbox + Oil bath chain			
Security	Torque limiter with dry friction and flywheel			
Transport dimension				
w	1930mm (76")	2190mm (86" 1/4)	2410mm (95")	2920mm (115")
L	1880mm (74")	1920mm (75" 1/2)	1890mm (74" 1/2)	1890mm (74" 1/2)
H	1120mm (44")	1120mm (44")	1120mm (44")	1120mm (44")
Weight with cast iron notched disc roller	955 Kg (2105.4 lb)	1120 Kg (2469.1 lb)	1198 Kg (2641.1 lb)	1421 Kg (3132.7 lb)

Options

- Rear mesh roller side adjustment device by cylinder
- Cast iron grooved disc roller + Scraper
- Stainless Steel Splice Seeder : SMC 150 / SMC 180 / SMC 200
- Gravity Grass Seeder : SG 150 for RDL 150



This soil preparer and stone burier is designed for tractors. It allows the building or renovation of green spaces by preparing the seed bed before seeding. The machine is multi-purpose, it allows tilling, burying (stones, rubbish, herbs, etc.), levelling, mixing and rolling the surface. The use is done live or on a ground previously decompacted in depth.

Technical details :

Machine	RX 200
Working width	2042 mm (80" 1/2)
Total width	2470 mm (97" 1/4)
Weight with mesh metal roller	1622 Kg (3575.8 lb)
Tractor : Required power	80 - 100 CV
Tractor : Max track width	2 meters (78" 3/4)
Working depth (max)	200 mm (8")
Rotor outer diameter	630 mm (24" 3/4)
Depth adjustment	Support on rear roller adjustable by screw jacks
Number of blades	60
Grid finger spacing	20 mm (4/5")
3 point hitch	Categorie 2
PTO speed	1000 tr/min
Tractor forward speed	0,8 to 1,5 km/h (0.5 to 0.9 mph)
Transmission	Angle gearbox + Oil bath chain
Machine drive type	Single drive
Security	Oil bath torque limiter at the end of the rotor
Transport dimension w x L x H (mm)	2470 mm x 2120 mm x 1340 mm (97" 1/4 x 83" 1/2 x 52" 3/4)

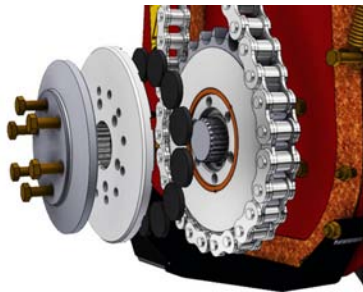

Oil bath torque limiter
at the end of the rotor



Option : Stainless Steel Splice
Seeder

Option	- Stainless Steel Splice Seeder : SMC 200 RX
--------	---



This soil preparer and stone burier allows the building or renovation of green spaces by preparing the seed bed before seeding. The machine is multi-purpose, it allows tilling, burying (stones, rubbish, herbs, etc.), levelling, mixing and rolling the surface. The use is done live or on a ground previously decompacted in depth.

Its particularity is that its transport width is 3 meters (118" 1/8).

Technical details :

Machine	RX 250-L3
Working width	2500 mm (98" 1/2)
Total width	2965 mm (116" 3/4)
Weight with mesh metal roller	1935 Kg (4263,7 lb)
Tractor : Required power	110 - 150 CV
Tractor : Max track width	2.45 meters (96" 1/2)
Working depth (max)	220 mm (8" 1/2)
Rotor outer diameter	630 mm (24" 3/4)
Depth adjustment	Support on rear roller adjustable by screw jacks
Number of blades	72
Grid finger spacing	20 mm (4/5")
3 point hitch	Categories 2 & 3
PTO speed	1000 tr/min
Tractor forward speed	0,8 to 1,5 km/h (0.5 to 0.9 mph)
Transmission	Angle gearbox + Oil bath chains
Machine drive type	Dual drive
Security	Torque limiter in oil bath at each end of the rotor
Transport dimension w x L x H	2965 mm x 2200 mm x 1290 mm (116" 3/4 x 83" 1/2 x 52" 3/4)
Weight with cast iron notched disc roller	-



Option : Cast iron grooved disc roller + Scraper



Option : Anti-groove system (ARS)

Options

- Cast iron grooved disc roller + Scraper
- Anti-groove system (ARS)



These soils preparer and stone buriers are designed for tractors. It allows the building or renovation of green spaces by preparing the seed bed before seeding. The machine is multi-purpose, it allows tilling, burying (stones, rubbish, herbs, etc.), levelling, mixing and rolling the surface. The use is done live or on a ground previously decompacted in depth.

Technical details :

Machines	RX 250	RX 300	RX 370
Working width	2500 mm (98" 1/2)	3050 mm (120")	3680 mm (145")
Total width	3370 mm (132" 1/2)	3870 mm (152" 1/4)	4620 mm (182")
Weight with mesh metal roller	1934 Kg (4263.7 lb)	2192 Kg (4832.5 lb)	2499 Kg (5509.3 lb)
Tractor : Required power	110 - 150 CV	110 - 160 CV	130 - 180 CV
Tractor : Max track width	2.45 meters (96" 1/2)	3 meters (118" 1/10)	3.60 meters (141" 3/4)
Working depth (max)	220 mm (8" 1/2)		
Rotor outer diameter	630 mm (24" 3/4)		
Depth adjustment	Support on rear roller adjustable by screw jacks		
Number of blades	72	90	108
Grid finger spacing	20 mm (4/5")		
3 point hitch	Categories 2 & 3		
PTO speed	1000 tr/min		
Tractor forward speed	0,8 to 1,5 km/h (0.5 to 0.9 mph)		
Transmission	Angle gearbox + Oil bath chains		
Machine drive type	Dual drive		
Security	Torque limiter in oil bath at each end of the rotor		
Transport dimension w x L x H	3370mm x 2360mm x 1290mm (132" 1/2 x 93" x 50" 3/4)	3870mm x 2220mm x 1290mm (152" 1/4 x 87" 1/2 x 50" 3/4)	4620mm x 1980mm x 1295mm (182" x 78" x 51")
Weight with cast iron notched disc roller	2280 Kg (5036.5 lb)	2588 Kg (5705.5 lb)	2978 Kg (6565.3 lb)
Weight with tire roller	2138 Kg (4713.4 lb)	2431 Kg (5359.4 lb)	2779 Kg (6126.6 lb)



Option : Pneumatic seeder



Option : Anti-groove system (ARS)

Options

- Tire roller
- Cast iron grooved disc roller + Scraper
- Pneumatic seeder : SMA 250 / SMA 300
- Anti-groove system (ARS)

SEEDING

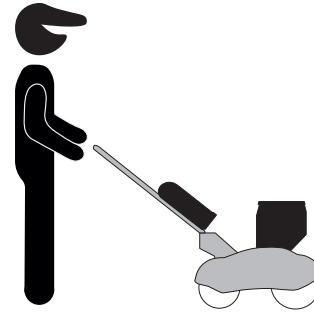

P. 38



P. 44

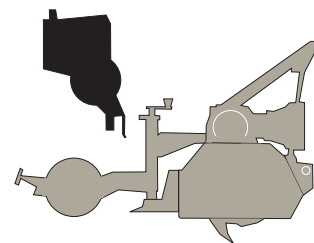

P. 50



The Rotadairon® SEEDCAR is a manual seeding machine designed for seeding all types of grass (bluegrass, red fescue or ray-grass). This gravity seeder is equipped with a graduated sector flow adjustment. For working comfort, the opening/ closing of the seeding is done from the handlebars. It also makes it possible to gear up and roll up all the «corners» of narrow or difficult access grounds.

The metal mesh roller, at the front, wafts the soil. Then the seed drill deposits the seeds. Finally the smooth rear roller, ideally compacts the soil to obtain a good germination and avoid the marking of the steps of the user.

Technical details :

Machine	SEEDCAR
Seeding width	700 mm (27" 1/2)
Total width	840 mm (33")
Front roller type	Metal mesh
Front roller diameter	Ø 220 mm (8" 1/2)
Rear roller type	Stainless steel smooth
Rear roller diameter	Ø 200 mm (7" 3/4)
Weight	51 Kg (112.4 lb)
Transport dimension w x L x H (mm)	860 mm x 780 mm x 1085 mm (33" 7/8 x 30" 3/4 x 42" 3/4)

Seeder

Type of seed drill	Stainless steel gravity seed drill
Seed rate ajustement	Adjustment dial 0 to 6
Seed rate calibration	Calibration bucket
Seed drill capacity	55 liters (14,5 US gal)

Option

- Seed dibbler
- Additional masses
14 Kg (30.8 lb)



Option : Seed dibbler



Option : Additional masses
14 Kg (30.8 lb)



Option : Extra battery



Option : Seed dibbler

The Rotadairon® e.SEEDCAR 750w is an electric assisted seeder which will allow you to comfortably turf your land and preserve the environment. The machine is fitted with a quiet electric motor and its battery has an autonomy of 60-90 min, allowing for about 2500 m² per cycle. The metal mesh roller, at the front, wafts the soil. Then the seed drill deposits the seeds. Finally the smooth rear roller, ideally compacts the soil to obtain a good germination and avoid the marking of the steps of the user.

Technical details :

Machine	e.SEEDCAR 750w
Seeding width	700 mm (27" 1/2)
Autonomy	60 - 90 minutes (≈ 2500 m ²)
Lithium battery	36 V / 11.6 Ah Supplied with charger 230 V (E/F plug) Full charging time : 3h30
Total width	840 mm (33")
Front roller type	Metal mesh
Front roller diameter	Ø 220 mm (8" 1/2)
Rear roller type	Stainless steel smooth
Rear roller diameter	Ø 200 mm (7" 3/4)
Weight	74 Kg (163 lb)
Transport dimension w x L x H (mm)	860 mm x 780 mm x 1085 mm (33" 7/8 x 30" 3/4 x 42" 3/4)
Seeder	
Type of seed drill	Stainless steel gravity seed drill
Seed rate ajustement	Adjustment dial 0 to 6
Seed rate calibration	Calibration bucket
Seed drill capacity	55 liters (14,5 US gal)

Options

- Extra battery
- Seed dibbler
- Additional masses
14 Kg (30.8 lb)



Calibration drawer

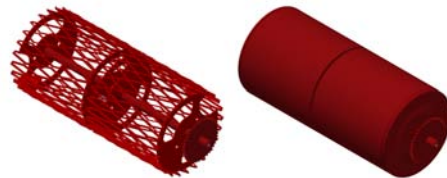

**Option : Double rear mesh roller or
Double rear smooth roller**

The Rotadairon® SD 700 is a self-propelled seeding machine designed for precision seeding, seed burial and field filling.

The Rotadairon® SD 700 can be used to sow the majority of grass varieties such as bluegrass, red fescue, ray grass, etc...

Reliable, handy and efficient, it allows you to sow quickly and effortlessly.

The metal mesh roller, at the front, wafts the soil. Then the seed drill deposits the seeds. Then the rotor claws the soil. Finally the smooth roller at the back compacts the soil ideally to obtain a good germination and avoid the marking of the steps of the user.

The Rotadairon® SD 700 is driven by the rear packer roller.

Technical details :

Machine	SD 700
Seeding width	700 mm (27" 1/2)
Total width	860 mm (33" 3/4)
Front roller type	Metal mesh
Front roller diameter	Ø 330 mm (13")
Rear roller type	Smooth
Rear roller diameter	Ø 330 mm (13")
Weight	232 Kg (512 lb)
Transport dimension w x L x H (mm)	860 mm x 1200 mm x 1310 mm (33" 7/8 x 47" 1/4 x 51" 5/8)

Motorization

Engine type	Honda thermal gas engine 4.5 HP
Engine air cleaner	Oil bath air cleaner
Transmission	4 forward speeds, 1 reverse

Seeder

Type of seed drill	Stainless steel gravity seed drill
Seed rate adjustment	Adjustment dial 0 to 6
Seed rate calibration	Calibration bucket
Seed drill capacity	55 liters (14,5 US gal)

Options

- Double rear mesh roller
- Double rear smooth roller



These seeding machines have been designed to sow most varieties of grass such as pastures, red fescue, ray-grass, etc. on large areas. It is equipped with a gravity seed drill and two cast iron rollers, allowing a single clutch passage. It is used on the ground previously worked with the aid of a soil preparer/stone burier.

Technical details :

Machines	SMG 155	SMG 205
Seeding width	1500 mm (59")	2000 mm (78" 3/4)
Total width	1800 mm (70" 3/4)	2245 mm (88" 1/2)
Weight	575 Kg (1267.6 lb)	712 Kg (1569.6 lb)
Tractor : Required power	30 - 60 CV	50 - 95 CV
Front roller type	Cast iron serrated disc roller	
Front roller diameter	Ø 400 mm (15" 3/4)	
Rear roller type	Cast iron serrated disc roller	
Rear roller diameter	Ø 295 mm (11" 1/2)	
3 point hitch	Categories 1 & 2	
Tractor forward speed	3 to 5 Km/h (1,8 to 3,1 mph)	
Transport dimension w x L x H	1800 mm x 1150 mm x 910 mm (70" 3/4 x 45" 1/4 x 35" 3/4)	2245 mm x 1150 mm x 910 mm (88" 1/2 x 45" 1/4 x 35" 3/4)

Seeder

Type of seed drill	Stainless steel gravity seeder	
Seed rate adjustment	Adjustment clock 0 to 12 o'clock	
Seed drill capacity	139 liters (37 US gal)	178 liters (47 US gal)

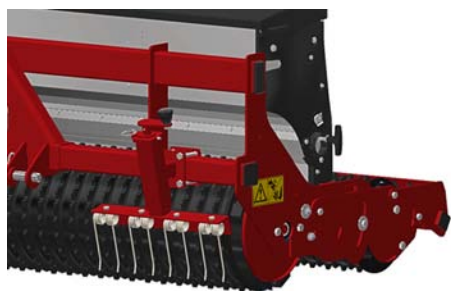

Wheel Eraser Claws



Stainless steel gravity seeder



This seeding machines has been designed to sow most varieties of grass such as pastures, fescue, ray-grass, etc. on large areas. It is equipped with a gravity seed drill and two cast iron rollers, allowing a single clutch passage. It is used on the ground previously worked with the aid of a soil preparer/stone burier. Its particularity is that its transport width is 3 meters (118'' 1/8).

Technical details :

Machines	SMG 300
Seeding width	2820 mm (111'')
Total width	3000 mm (118'' 1/8)
Weight	1100 Kg (2425 lb)
Tractor : Required power	50 - 95 CV
Front roller type	Cast iron serrated disc roller
Front roller diameter	Ø 400 mm (15'' 3/4)
Rear roller type	Cast iron serrated disc roller with intermediate discs
Rear roller diameter	Ø 295 mm (11'' 1/2)
3 point hitch	Categories 1 & 2
Tractor forward speed	Max 12 Km/h (Max 7.5 mph)
Transport dimension w x L x H	3000 mm x 1110 mm x 1000 mm (118'' 1/8 x 43'' 1/4 x 39'' 1/3)

Seeder

Type of seed drill	Stainless steel gravity seeder
Seed rate adjustment	Adjustment clock 0 to 12 o'clock
Seed rate	0 to 50 g/m ² (Depends on seed type)
Seed drill capacity	600 litres (158 US gal)

Option

Wheel Eraser Claws



Quick opening / closing at the cockpit



Option : Wheel Eraser Claws



This seeder has been designed to seed most varieties of turf such as pastures, fescues, ryegrass, etc. on large surfaces. It is equipped with a pneumatic seeder and two cast iron rollers, allowing seeding in one pass. It is used on land previously worked with a soil preparation/stone burier.

Technical details :

Machine	SMA 305
Seeding width	3310 mm (130" 1/4)
Total width	3600 mm (141" 3/4)
Weight	1640 Kg (3615,5 lb)
Tractor : Required power	60 - 100 CV
Front roller type	Cast iron serrated disc roller
Front roller diameter	Ø 400 mm (15" 3/4)
Rear roller type	Cast iron serrated disc roller
Rear roller diameter	Ø 295 mm (11" 1/2)
3 point hitch	Categorie 2
Tractor forward speed	3 to 8 Km/h (1,8 to 5 mph)
Transport dimension w x L x H	3600 x 2420 x 2340 (141" 3/4 x 95" 1/4 x 92")

Seeder

Type of seed drill	Pneumatic seed drill
Seed rate ajustement	Dosing ruler
Seed drill capacity	750 liters (198 US gal)

Option

Available in double rear cast iron rollers

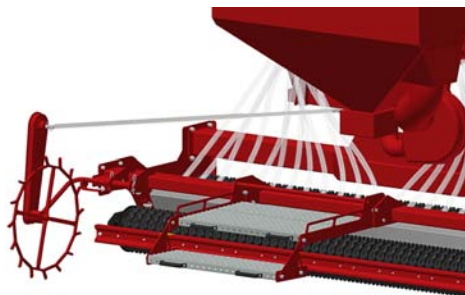

Access platform for the tank



Pneumatic seeder



SG gravity grass seeder are designed to be paired with soil preparation machines. They allow you to sow immediately after soil preparation. You can bury the stones, prepare the soil and sow in one pass, this set allows to spread most of varieties of grass. A real time saver!

The SG are compatible with most stone buriers and are available in several sizes.

Technical details :

Machines	SG 90	SG 100	SG 130	SG 145 - 150
Mounting on machine type	STONY 90 STH 36	STONY 115 RD 100 STH 42	RD 130	RDH 60 RCH 60 RD 145 RDL 150
Seeding width	900 mm (35")	1000 mm (39" 3/8)	1300 mm (51" 1/5)	1500 mm (59")
Total width	1210 mm (47" 5/8)	1340 mm (52" 3/4)	1600 mm (63")	1750 mm (68" 7/8)
Seed rate adjustement	Graduated dial			
Seed drill capacity	75 liters (20 US gal)	80 liters (21 US gal)	110 liters (29 US gal)	120 liters (32 US gal)
Weight	35 Kg (77.2 lb)	40 Kg (88.2 lb)	50 Kg (110.3 lb)	60 Kg (132.2 lb)
Transport dimension w x L x H	1210mm x 620mm x 420mm (47" 5/8 x 24" 2/5 x 16" 1/2)	1340mm x 620mm x 420mm (52" 3/4 x 24" 2/5 x 16" 1/2)	1600mm x 620mm x 420mm (63" x 24" 2/5 x 16" 1/2)	1750mm x 620mm x 420mm (68" 7/8 x 24" 2/5 x 16" 1/2)



Mixer for decompacting seeds in the seedbox



SG 130 on soil preparator RD 130



SMC spline drills are designed to be paired with soil preparation machines. They allow you to sow with precision immediately after soil preparation. You can bury the stones, prepare the soil and sow in one pass. A real time saver! The SMC are compatible with most stone buriers and are available in several sizes.

Technical details :

Machines	SMC 90	SMC 100	SMC 130	SMC 145
Mounting on machine type	STONY 90	STONY 115 RD 100	RD 130	RD 145
Seeding width	960 mm (37" 7/8)	1060 mm (41" 6/8)	1325 mm (52" 1/8)	1540 mm (60" 5/8)
Total width	1180 mm (46" 1/2)	1280 mm (50" 1/2)	1540 mm (60" 5/8)	1760 mm (69" 1/3)
Number of distributors	40	44	55	64
Seed rate adjustment	Adjustment clock 0 to 12 o'clock			
Seed drill capacity	87 liters (23 US gal)	95 liters (25 US gal)	120 liters (32 US gal)	139 liters (37 US gal)
Weight	45 Kg (99 lb)	48 Kg (105 lb)	56 Kg (123.5 lb)	62 Kg (136.7 lb)
Transport dimension w x L x H	1180mm x 490mm x 630mm (46" 1/2 x 19" 3/8 x 24" 7/8)	1280mm x 490mm x 630mm (50" 1/2 x 19" 3/8 x 24" 7/8)	1540mm x 490mm x 630mm (60" 5/8 x 19" 3/8 x 24" 7/8)	1760mm x 490mm x 630mm (69" 1/3 x 19" 3/8 x 24" 7/8)

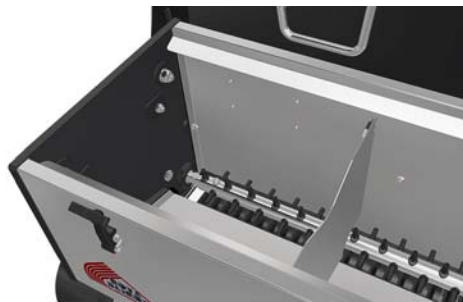

Stainless steel seeder with adjustable seed distribution



SMC 130 on soil preparator RD 130

Machines	SMC 150	SMC 180	SMC 200	SMC 200 RX
Mounting on machine type	RDL 150	RDL 180	RDL 200	RX 200
Seeding width	1540 mm (60" 5/8)	1775 mm (69" 7/8)	1950 mm (76" 6/8)	1950 mm (76" 6/8)
Total width	1760 mm (69" 1/3)	2165 mm (85" 1/4)	2165 mm (85" 1/4)	2165 mm (85" 1/4)
Number of distributors	64	75	81	81
Seed rate adjustment	Adjustment clock 0 to 12 o'clock			
Seed drill capacity	139 liters (37 US gal)	178 liters (47 US gal)	178 liters (47 US gal)	178 liters (47 US gal)
Weight	62 Kg (136.7 lb)	74 Kg (163 lb)	74 Kg (163 lb)	74 Kg (163 lb)
Transport dimension w x L x H	1760mm x 490mm x 630mm (69" 1/3 x 19" 3/8 x 24" 7/8)	2165mm x 490mm x 630mm (85" 1/4 x 19" 3/8 x 24" 7/8)	2165mm x 490mm x 630mm (85" 1/4 x 19" 3/8 x 24" 7/8)	2165mm x 490mm x 630mm (85" 1/4 x 19" 3/8 x 24" 7/8)

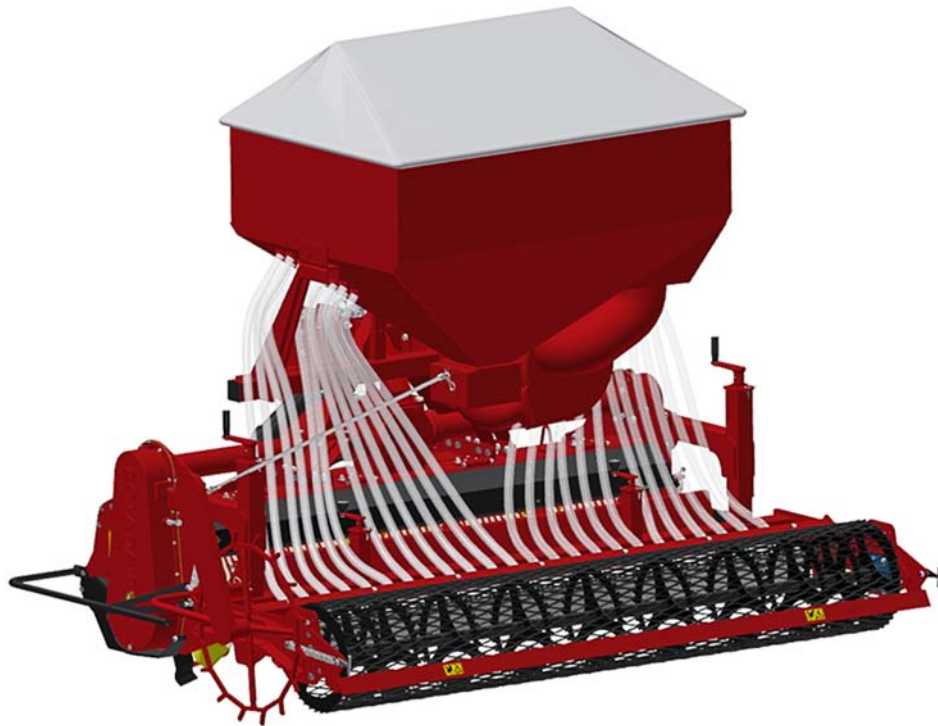

The SMA pneumatic seed drills are designed to be paired with the RX type soil preparation machines. They allow seeding immediately after soil preparation. This means that only one pass is needed to bury the stones, prepare the soil and sow. A real time saver!

Technical details :

Machines	SMA 250	SMA 300
Mounting on machine type	RX 250	RX 300
Working width	2500 mm (98" 1/2)	3000 mm (118" 1/8)
Seed rate adjustment	Dosing ruler	
Seed drill capacity	750 liters (198 US gal)	

OVERSEEDING

P. 58





Special tire roller



Clean cut by sharp discs

These overseeding machines allow you to perform your over-seeding operations in an economical way. The rotating knives create a groove in which the pods deposit the seeds. The machine allows a high precision seeding which is obtained by volumetric adjustment of all the cells constituting the rotor of the seed drill. The furrows are closed, naturally, by the elasticity of the grass but also by the passage of the roller with special tires. The cleaning of the tank is simplified thanks to the tool-free extraction of the agitator.

Technical details :

Machines	RG 140	RG 200
Working width	1400 mm (55" 1/8)	1830 mm (72")
Total width	1790 mm (70" 1/2)	2270 mm (89" 1/4)
Weight	485 Kg (1069.2 lb)	580 Kg (1278.6 lb)
Tractor : Required power	18 - 25 CV	25 - 60 CV
Working depth (max)	0 to 60 mm (0" to 2" 1/4)	
Interval between sowing	48 mm (1" 7/8)	
Rotor outer diameter	400 mm (15" 3/4)	
Number of knives	90	117
Depth adjustment	Screw jack system	
3 point hitch	Categories 1 & 2	
PTO speed	540 tr/min	
Tractor forward speed	0,8 to 1,5 Km/h (0.5 to 0.9 mph)	
Transmission	Angle gearbox + Oil bath chain	
Transport dimension w x L x H	1790 mm x 1430 mm x 930 mm (70" 1/2 x 56" 1/4 x 36" 1/2)	2270 mm x 1500 mm x 930 mm (89" 1/4 x 59" x 36" 1/2)
Seeder		
Type of seed drill	Stainless steel seed drill by spline distributor	
Seed rate ajustement	Adjustment clock 0 to 12 o'clock	
Seed drill capacity	130 liters (34 US gal)	178 liters (47 US gal)



This overseeding machine allows you to perform your over-seeding operations optimally. Each disc/injector unit produces a clean cut and precise deposit of seeds. This unique design allows us to offer you a compact machine with a limited weight allowing the selection of a tractor with less lifting capacity.

The cutting of the groove is carried out by sharp discs, arranged on independent blocks that follow the profile of the ground. The injectors place the seeds precisely in the furrows.

The precision seeding, of the classic English ray-grass mixtures, red fescue... is obtained by the volumetric adjustment of the spline dispenser via the dial clock.

The rear roller then closes the grooves.

Technical details :

Machines	ROOG 150.60
Working width	1500 mm (59")
Total width	1760 mm (69" 1/4)
Weight	665 Kg (1466 lb)
Tractor : Required power	From 30 CV (Check the lifting capacity of the tractor)
Seeding depth	0 to 20 mm (0" to 3/4")
Interval between sowing	60 mm (2" 1/4)
Number of discs	24
Depth adjustment	3rd point + roll
3 point hitch	Categories 1 & 2
Transport dimension w x L x H (mm)	1760 mm x 1010 mm x 1490 mm (69" 1/4 x 58" 3/4 x 39" 3/4)
Seeder	
Type of seed drill	Stainless steel seed drill by spline distributor
Seed rate adjustment	Adjustment clock 0 to 12 o'clock
Seed rate calibration	From 2 to 30 g/m ²
Seed drill capacity	139 liters (37 US gal)

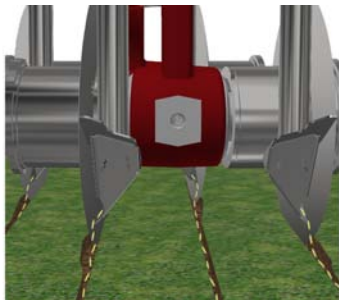

Clean cut by sharp discs

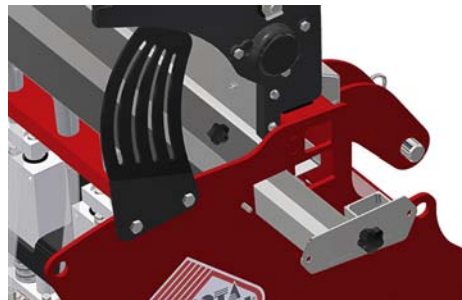

Calibration device

DETHACHING - SPIKING

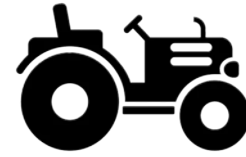

P. 64





Option n°1 : Rear roller



Option n°2 : « SWING »
(Option 1 required)

The DS Dethatchers Spikers are the evolution of our proven “ED” models well known for their superior dethatching qualities with their unique blade fixing system, accepting 3 variants of knives to precisely meet your needs.

These dethatching machines allow to perform dethatching or scarifying operations at the desired depth (from 0 to 60 mm). In addition to these operations, the machines allow to carry out an aeration of the ground (spiking effect, without power take-off) or a rolling. The machines are equipped with a quick-change blade system (Rotadairon® patent). The blades are positioned magnetically on their support. All the supports are locked by a single nut at the end of the rotor axis.

3 knife configurations are available (See ED 130 TS)

Technical details :

Machines	DS 130	DS 180
Working width	1300 mm (51" 1/4)	1800 mm (70" 3/4)
Total width	1560 mm (61" 1/2)	1945 mm (76" 2/3)
Weight	288 Kg (635 lb) With option n°1 : 316 Kg (697 lb) With option n°1 & 2 : 340 Kg (750 lb)	330 Kg (728 lb) With option n°1 : 365 Kg (805 lb) With option n°1 & 2 : 389 Kg (858 lb)
Tractor : Required power	25 - 45 CV	30 - 45 CV
Working depth	0 to 60 mm (0" to 2" 1/4)	
Distance between knives	24 mm (15/16")	
Rotor outer diameter	360 mm (14" 1/4)	
Depth adjustment	Basic machine: Adjustment at the 3rd Points Machine with options: Height adjustable rollers	
Number of flanges	53	74
Number of knives	159	222
3 point hitch	Categories 1 & 2	
PTO speed	540 tr/min	
Tractor forward speed	3 to 8 Km/h (1,8 to 4,9 mph)	
Transmission	Angle gearbox + Oil bath chain	
Transport dimension w x L x H	1560 mm x 895 mm x 840 mm (61" 1/2 x 35" 1/4 x 33")	1945 mm x 895 mm x 840 mm (76" 2/3 x 35" 1/4 x 33")

Options

Option n°1 : Rear roller
Option n°2 : « SWING »



This dethatching / collecting machine allows to carry out the dethatching operations of a green in one pass. The machine has a patented sweeping system with hydraulic drive. The hydraulically discharged collection container, with a capacity of 180 liters, allows for the clearing of a whole green. In addition to these operations, the machine can also be used to aerate the ground (spiking effect, without power take-off) or to roll. The machine is equipped with a quick-change blade system (Rotadairon® patent). The blades are positioned magnetically on their support. All the supports are locked by a single nut at the end of the rotor axis.

3 knife configurations :

- **a** Sharpened (standard): Stainless steel knife sharpened for classic de-thatching
- **b** Not sharpened: Made of stainless steel knives not sharpened for more aggressive de-thatching
- **c** Carbide plate: Carbon steel with carbide plate for very aggressive de-thatching

Technical details :

Machine	ED 130 TS
Working width	1300 mm (51" 1/4)
Total width	1840 mm (72" 1/2)
Weight	366 Kg (806.8 lb)
Tractor : Required power	25 - 45 CV
Working depth	0 to 60 mm (0" to 2" 1/4)
Distance between knives	24 mm (15/16")
Rotor outer diameter	360 mm (14" 1/4)
Depth adjustment	Front roller support with 2 marked positions + Rear roller support adjustable by screw jack
Number of flanges	53
Number of knives	159
3 point hitch	Categories 1 & 2
PTO speed	540 tr/min
Tractor forward speed	3 to 8 Km/h (1,8 to 4,9 mph)
Transmission	Angle gearbox + Oil bath chain
Transport dimension w x L x H	1840 mm x 1420 mm x 840 mm (72" 1/2 x 56" x 33")



3 knife configurations

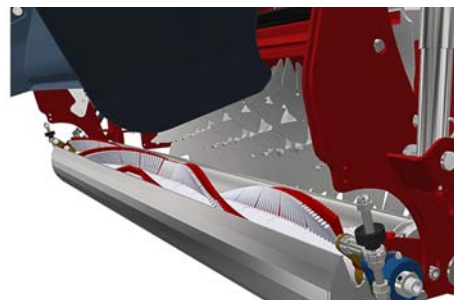

Hydraulic system (Motor) for perfect felt collection

MULCHING



P. 70

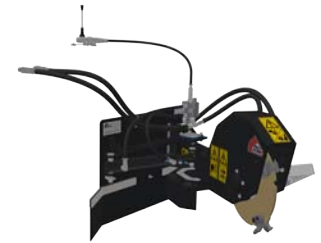

P.72

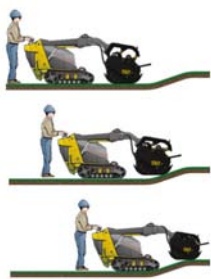

Floating field following system



Y-shaped mounting of knives on shackles

This mulcher was designed to grind dense herbs and brambles. It achieves a very high performance thanks to the floating system (Rotadairon® Patent) which allows to follow perfectly and automatically the unevenness of the ground.

It is equipped with a device that complies with the regulations in force (EN12733) allowing the machine to be stopped quickly: as soon as the operator releases the controls and the machine ceases to be supplied with oil, our system brakes and stops the rotor in less than 7 seconds.

The Y-mounting of knives on shackles contributes to a better grinding.

Technical details :

Machines	BRD 50	BRD 50 E	BRD 50 B
Hitch plate	Conventional quick coupler system Toro / Ditch-witch / Vermeer		Quick coupler system Bobcat MT
Working width	1270 mm (50")		
Total width	1440 mm (56" 3/4)		
Weight	276 kg (608 lb)		310 kg (683 lb)
Carrier : Hydraulic flow	40 à 60 l/min (10,5 to 15,8 US gpm)	40 à 55 l/min (10,5 to 14,5 US gpm)	40 à 60 l/min (10,5 to 15,8 US gpm)
Carrier : Pressure	210 bars (3045 psi)	200 bars (2900 psi)	210 bars (3045 psi)
Carrier : Maximum track width	1.27 meters (50")		
Working height	30 à 70 mm (1" 1/4 to 2" 3/4)		
Rotor outer diameter	366 mm (14" 3/8)		
Depth adjustment	Adjustable skids 3 positions		
Number of knives	76		
Number of shackles	38		
Forward speed of the carrier	0.8 à 1,5 Km/h (0.5 to 0.9 mph)		
Hydraulic control block*	Yes	No	Yes
Transmission	Hydraulic motor + Chain in oil bath		
Security	Hydraulic safety block		
Transport dimension w x L x H	1440 mm x 950 mm x 690 mm (56"3/4 x 37"1/2 x 27"1/4)		

*Necessary for hydraulic carrier to comply standards.



This machine is designed to be mounted on a skid-steer. It is designed for trimming, planing and crushing stumps. It is equipped with a unique control system which allows you to control the sweeping speed to suit the essences of stumps to be treated.

Technical details :

Machine	RS 480
Hitch plate	Toro / Ditch-witch / Vermeer
Sweep amplitude	1110 mm (43" 5/7)
Weight	160 kg (352.7 lb)
Carrier : Hydraulic flow	30 à 65 l/min (9,2 to 17,1 US gpm)
Carrier: Pressure (max)	230 bars (3335 psi)
Trimmer rotor diameter with teeth	480 mm (18" 7/8)
Number of teeth	4 pairs (Optional : 8 pairs)
Tooth type	Carbide teeth
Sweep control	Proportional control
Forward speed	0.8 à 1,5 Km/h (0.5 to 0.9 mph)
Rotor drive	Live motor
Transport dimension w x L x H	1080 mm x 1010 mm x 700 mm (42"1/2 x 39"4/5 x 27"4/7)



Sweeping speed control



Remote control with magnetic base

SPECIAL APPLICATIONS



P. 76

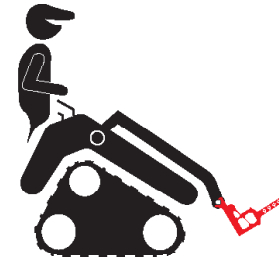
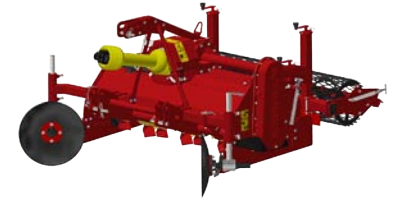

P. 78



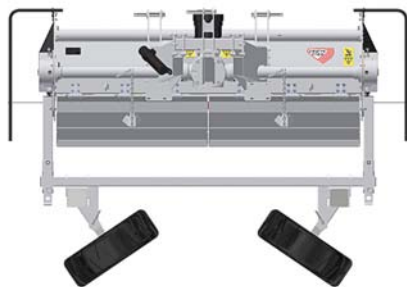

Option DCE 250 : Retractable wheels for road transport

The Rotadairon® DCE 250/300 are designed for agriculture applications. Their oversized rotor with double drive is designed to fight against the effect of battance, formed under the action of intense rain and trampling.

Equipped with oversized tiller with double drive, the DCE 250/300 are specially designed for applications in difficult soils.

Technical details :

Machines	DCE 250	DCE 300
Working width	2500 mm (98" 1/2)	3050 mm (120")
Total width	3365 mm (132" 1/2)	3920 mm (154" 1/4)
Weight	1370 Kg (3020.3 lb)	1470 Kg (3240.7 lb)
Tractor : Required power	90 - 110 CV	110 - 150 CV
Tractor : Max track width	2.5 meters (98" 1/2)	3.05 meters (120")
Working depth (max)	200 mm (7" 3/4)	
Rotor outer diameter	600 mm (23" 1/2)	
Depth adjustment	Support on Rear tires adjustable by screw jacks	
Number of blades	54	66
3 point hitch	Categories 2 & 3	
PTO speed	1000 tr/min	
Tractor forward speed	0,8 to 1,5 km/h (0.5 to 0.9 mph)	
Transmission	Angle gearbox + Oil bath chains	
Machine drive type	Dual drive	
Security	Torque limiter in oil bath at each end of the rotor	
Transport dimension w x L x H	3365 mm x 1825 mm x 1275 mm (132" 1/2 x 71" 3/4 x 50" 1/4)	3920 mm x 1825 mm x 1275 mm (154" 1/4 x 71" 3/4 x 50" 1/4)
Option	DCE 250 : Retractable wheels for road transport	



Option : Front disk



Soil preparation principle

The TERRAGRO developed by ROTADAIRON in collaboration with the professionals of the horticultural and market gardening sector is a preparator-burier for seedbeds or plantations, in beds or in forms. The TERRAGRO works the soil surface and respects its agronomic structure.

Its oversized rotor with reverse rotation throws stones, plant waste and soil against the selection grid, and, by densimetry, deposits the coarse elements which are then covered with fine soil.

The beds have, in all points, a perfect homogeneity of density which favors a more grouped germination of seeds and a faster recovery of the plants.

The TERRAGRO can thus work in all types of soil (sand, clay, silt, pebbles) while ensuring an ideal quality of preparation.

Technical details :

Machines	TR 130	TR 150	TR 170
Working width	1300 mm (51" 1/4)	1500 mm (59")	1770 mm (69" 2/3)
Total width	1680 mm (66" 1/6)	1880 mm (70" 4/5)	2100 mm (82" 2/3)
Weight	800 kg (1763 lb)	850 kg (1873 lb)	900 kg (1984 lb)
Tractor : Required power	35 à 60 CV	45 à 70 CV	50 à 95 CV
Tractor : Max track width	1.5 meters (59")	1.7 meters (66" 4/5)	1.9 meters (74" 2/3)
Working depth (max)	160 mm (6" 1/4)		
Rotor outer diameter	400 mm (15" 3/4)		
Depth adjustment	Support on rear roller adjustable by screw jacks		
Number of blades	42	48	54
Grid finger spacing	35 mm (1" 3/8)		
3 point hitch	Categories 1 & 2		
PTO speed	540 tr/min		
Tractor forward speed	0.8 to 1,5 Km/h (0.5 to 0.9 mph)		
Transmission	Angle gearbox + Oil bath chain		
Security	Torque limiter with dry friction and flywheel		
Transport dimension w x L x H	1700mm x 2100mm x 1200mm (66"4/5 x 82"2/3 x 47"1/4)	1900mm x 2100mm x 1200mm (74"2/3 x 82"2/3 x 47"1/4)	2100mm x 2100mm x 1200mm (82"2/3 x 82"2/3 x 47"1/4)

Option

Front discs

For any specific request,
Please contact your Rotadairon® dealer

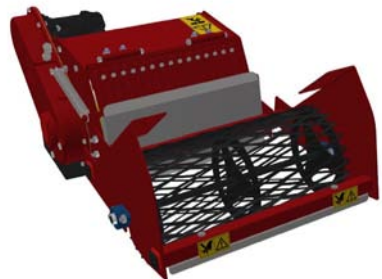

Version : Mesh metal roller

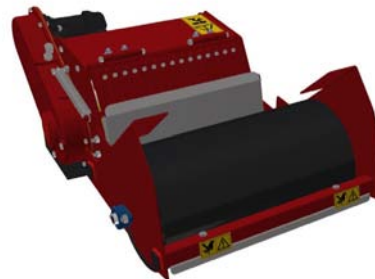

Version : Smooth roller

This soil preparer interface on multi-tool frame (ex : boisselet).It allows maintenance of inter-row vines.

The machine is multi-propose, it allows tilling, burying (stones,rubbish, herbs,etc...), levelling, mixing and rolling the surface. It can be used directly or on a ground previously decompacted.

Technical details :

Machines	RV 50
Working width	500 mm (19" 2/3)
Total width	690 mm (27" 1/6)
Weight with mesh metal roller	120 Kg (264.5 lb)
Weight with smooth metal roller	136 Kg (299.8 lb)
Hydraulic flow	30 à 50 l/min (7.9 to 13.2 US gpm)
Working depth (maxi)	140 mm (5" 1/2)
Pressure	180 bars (2610 psi)
Rotor outer diameter	400 mm (15" 3/4)
Number of blades	8
Grid finger spacing	20 mm (4/5")
Hitch plate	Multi-tool frame
Forward speed of the carrier	0,8 à 1,5 km/h (0.5 to 0.9 mph)
Required power	18-25 CV
Rotor transmission	Hydraulic motor + Chain in oil bath
Security	Made by the carrier
Transport dimension (mm) w x L x H	690 mm x 1200 mm x 550 mm (27" 1/6 x 47" 1/4 x 21" 2/3)

Versions

- Mesh roller
- Smooth roller

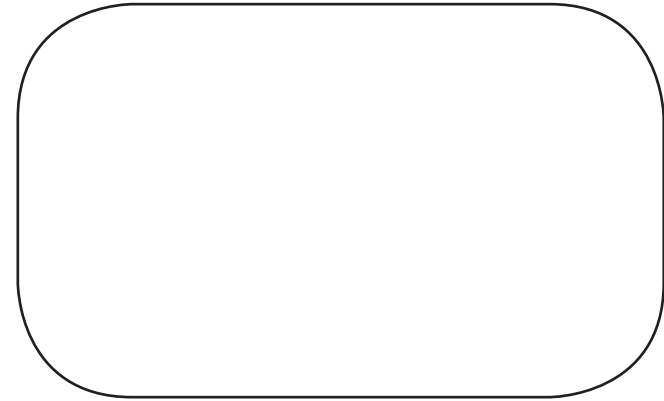

www.rotadairon.fr

Mail : contact@rotadairon.fr



ROTADAIRON
Départementale 92 - Les Hunaudières
72230 MULSANNE - FRANCE
Phone number : (33) 2 43 422 422